

LANGSDOORSNEDE OVER H.S.

DOORSN\_SPT\_39  
SPT\_38 - IS GROOTSPT

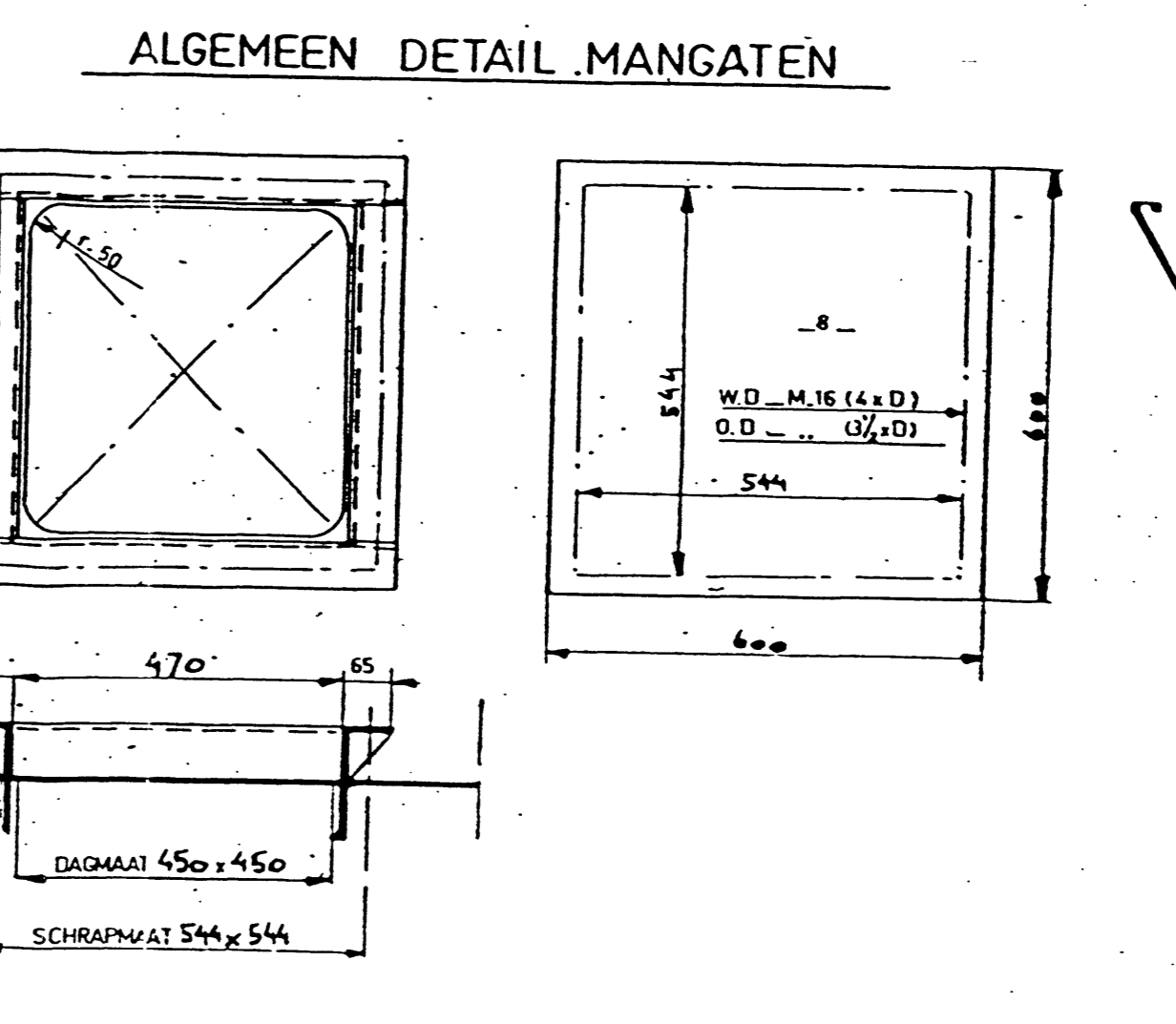
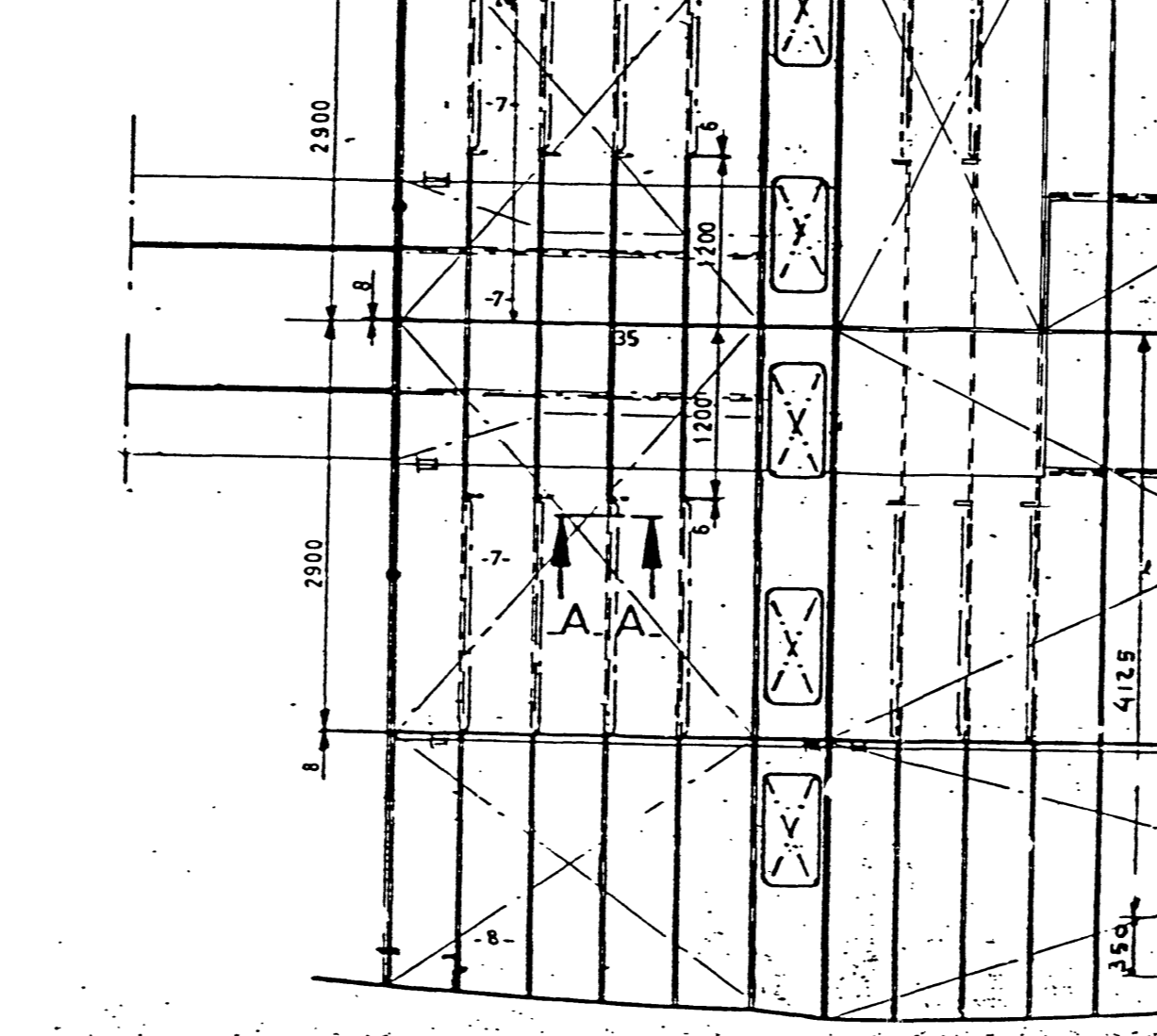
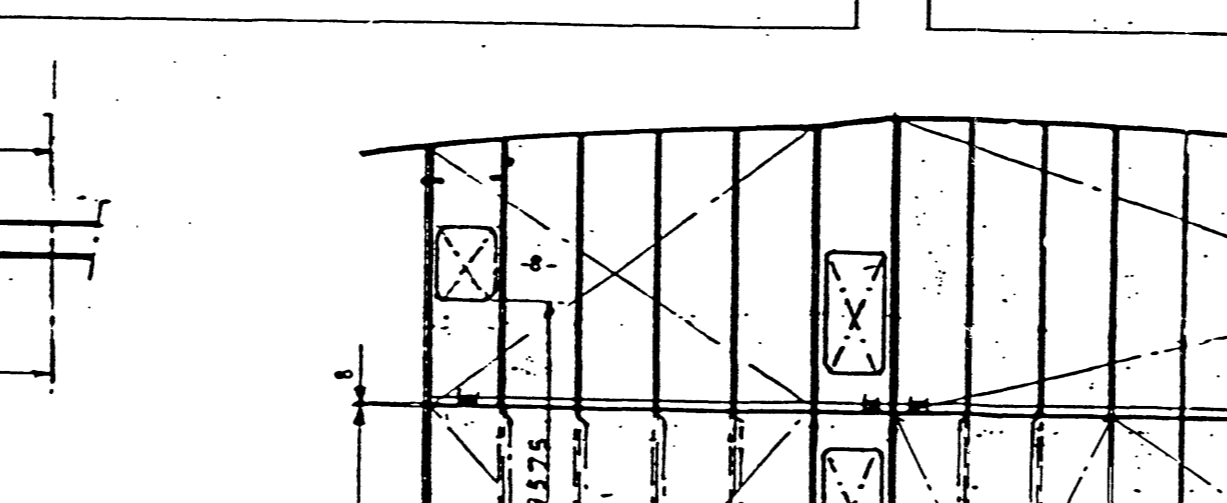
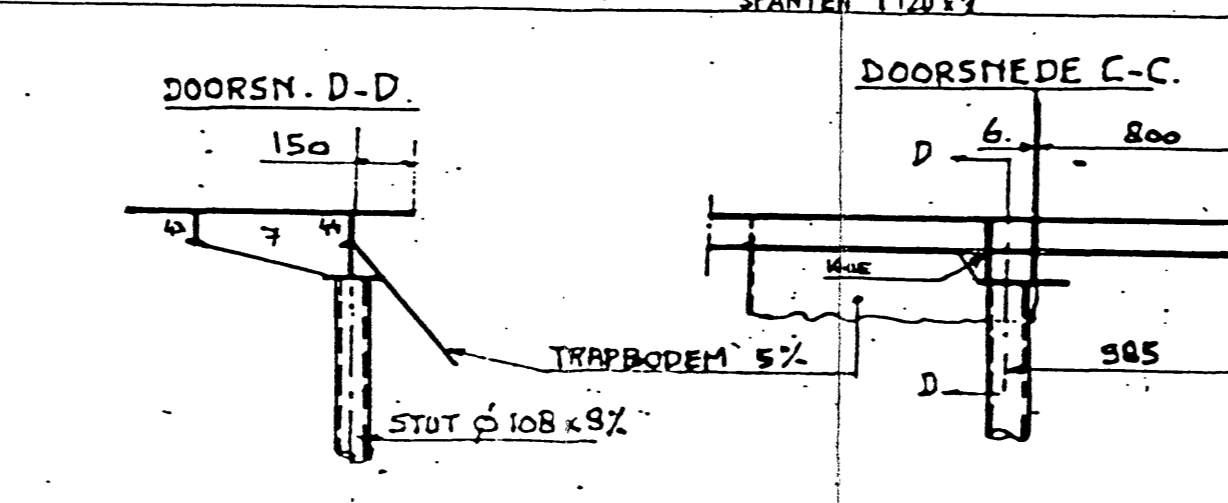
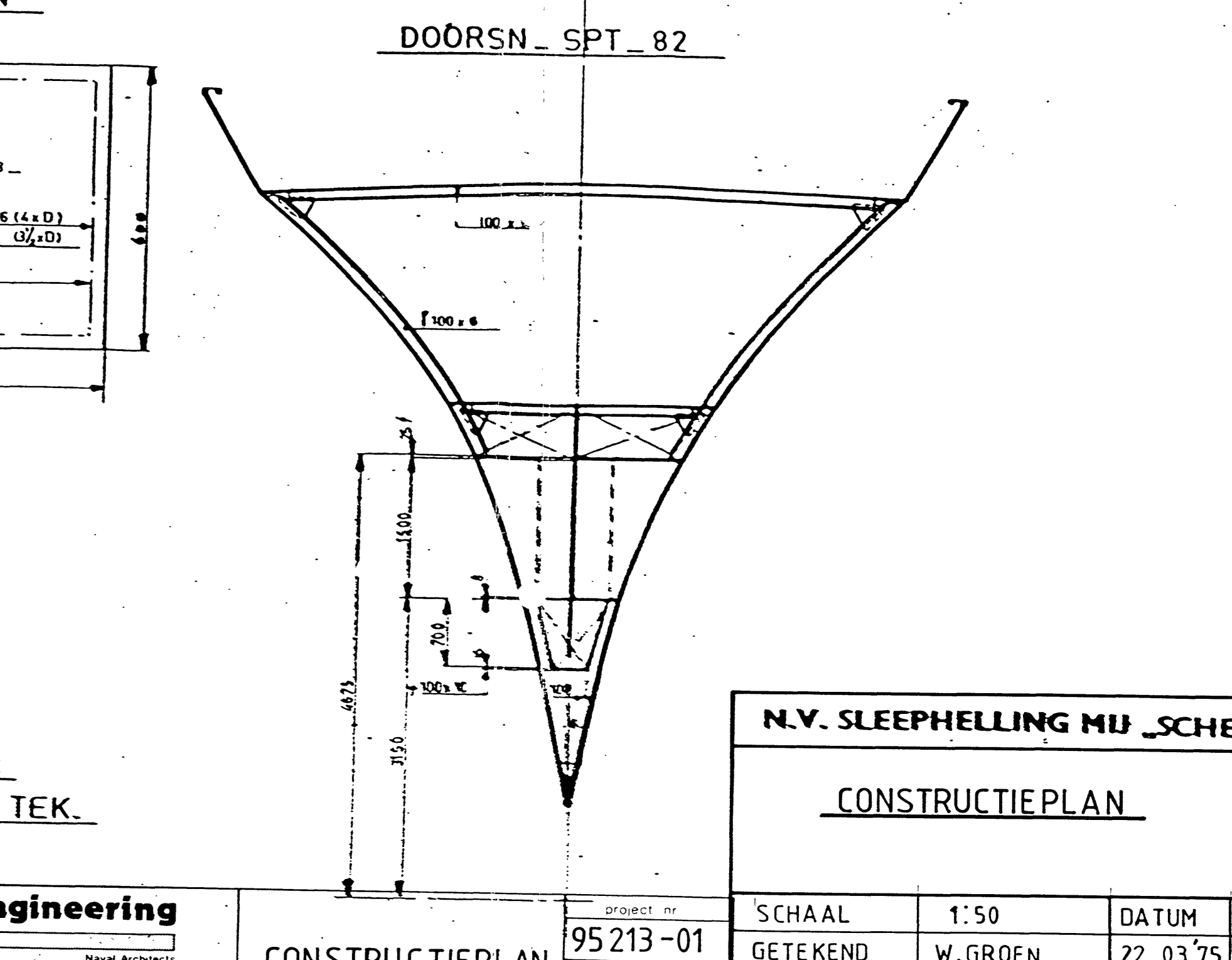
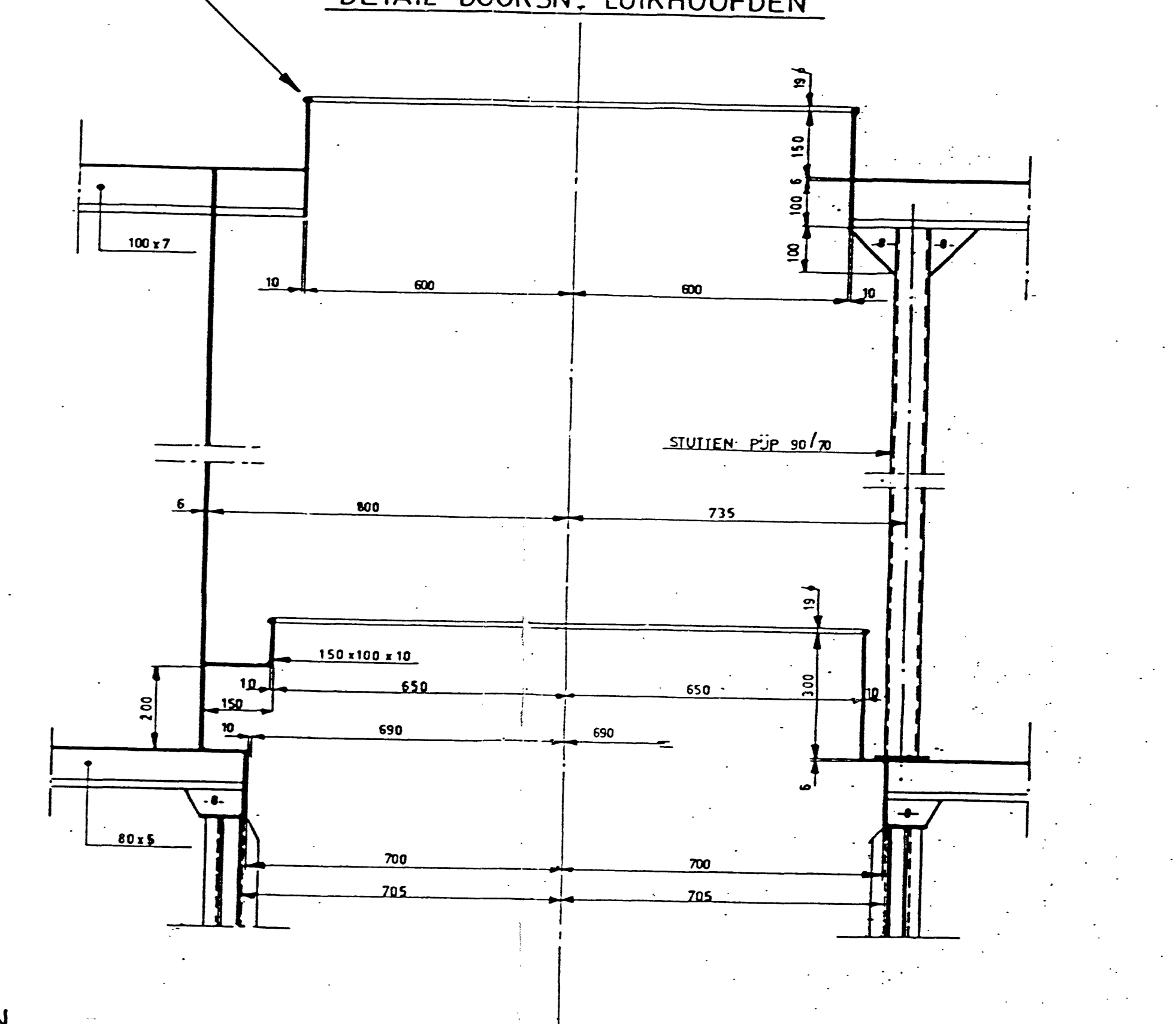
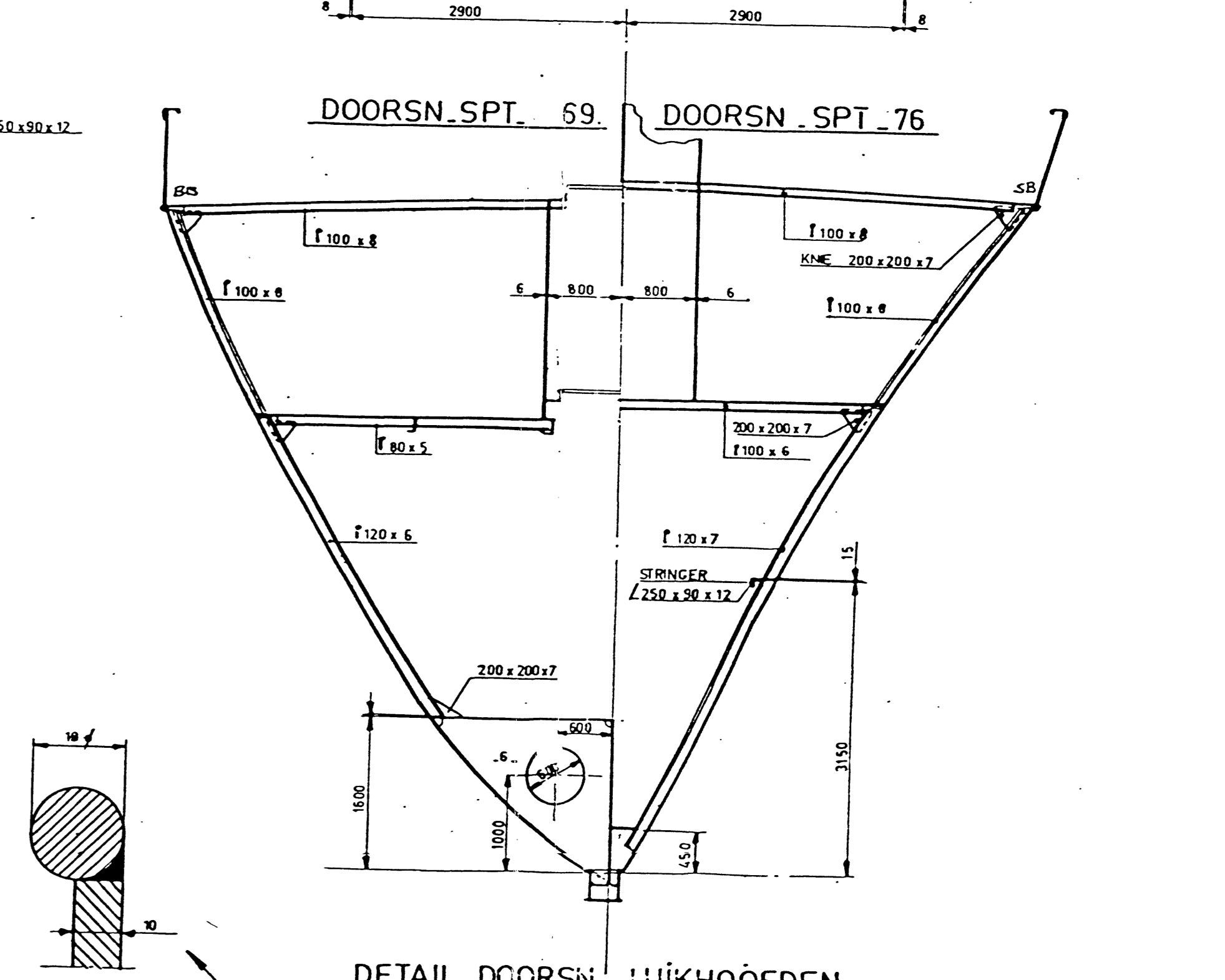
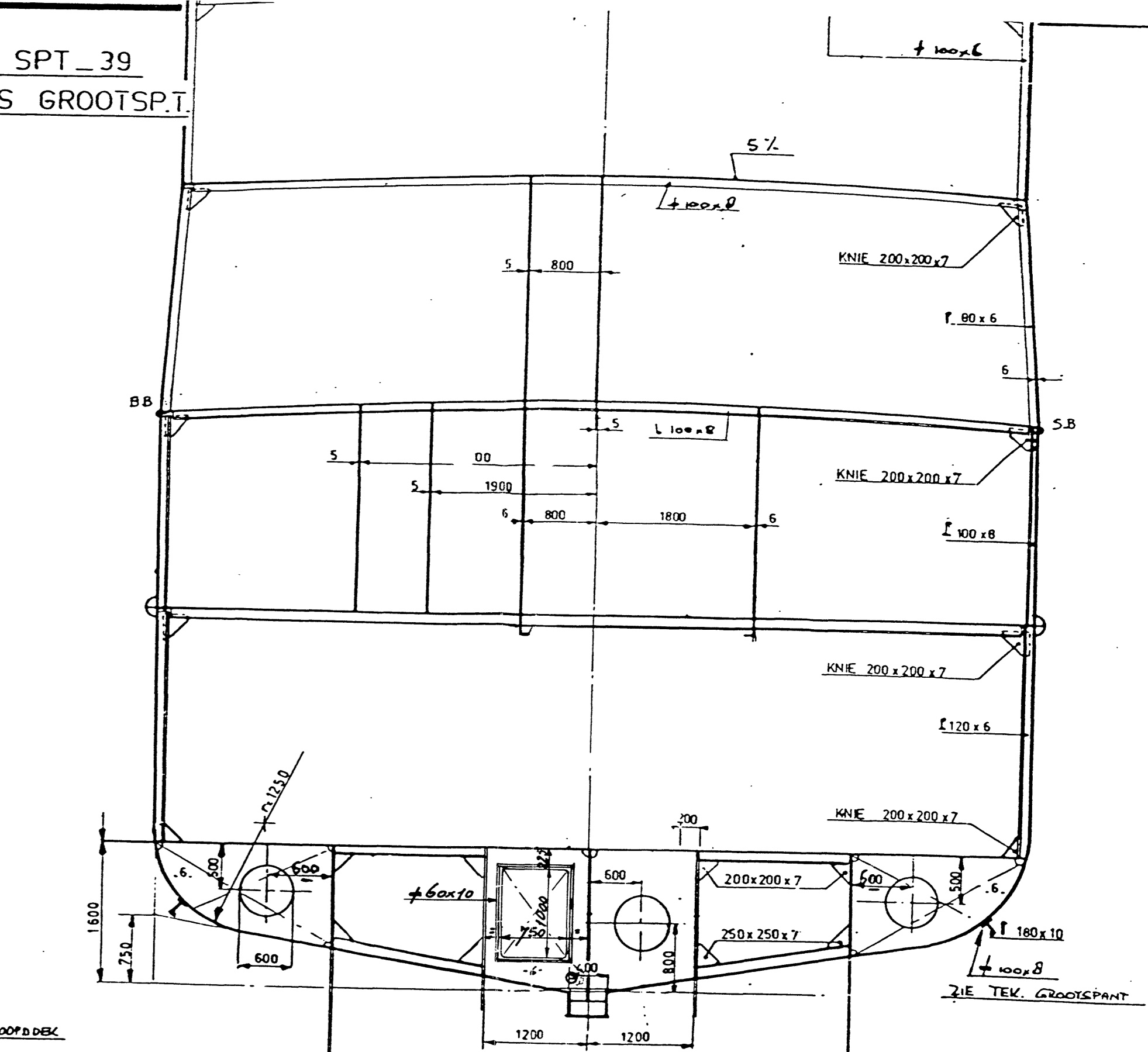
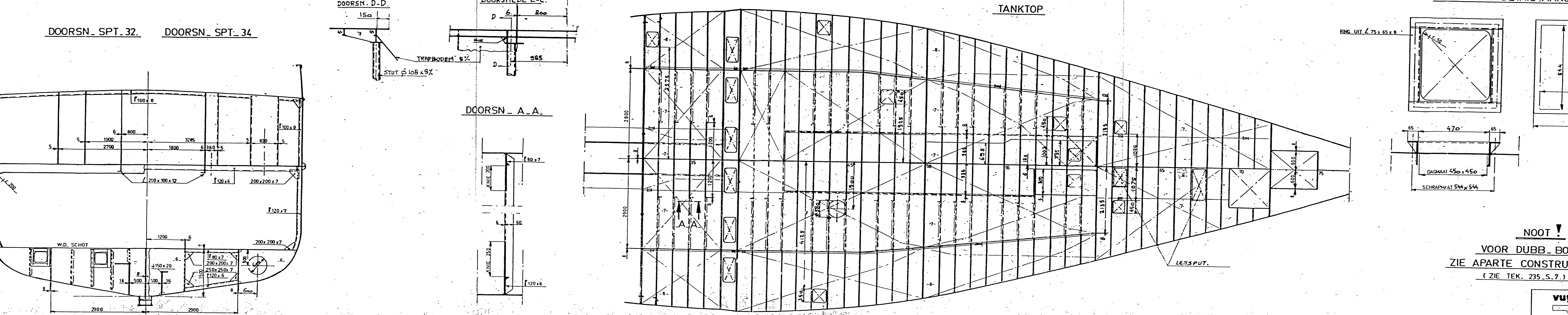
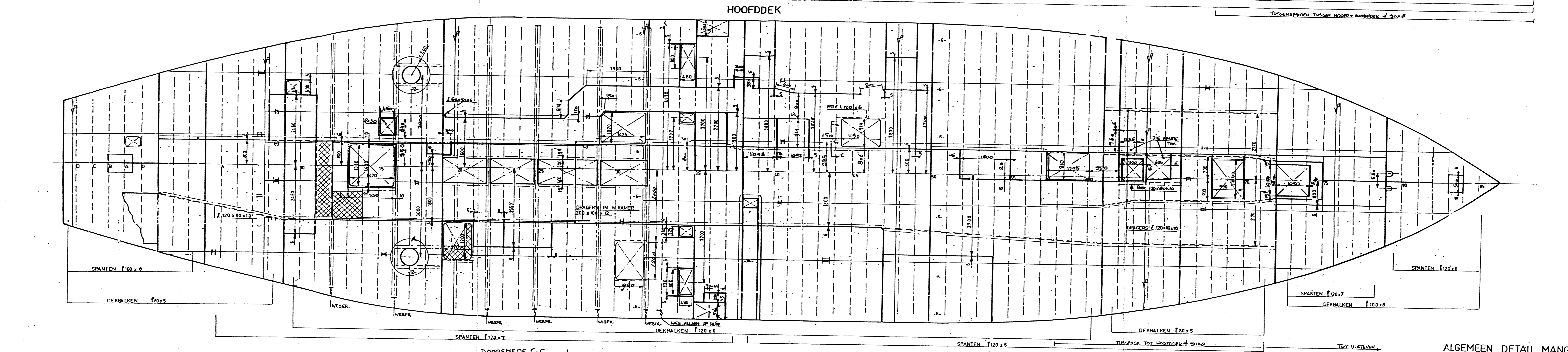
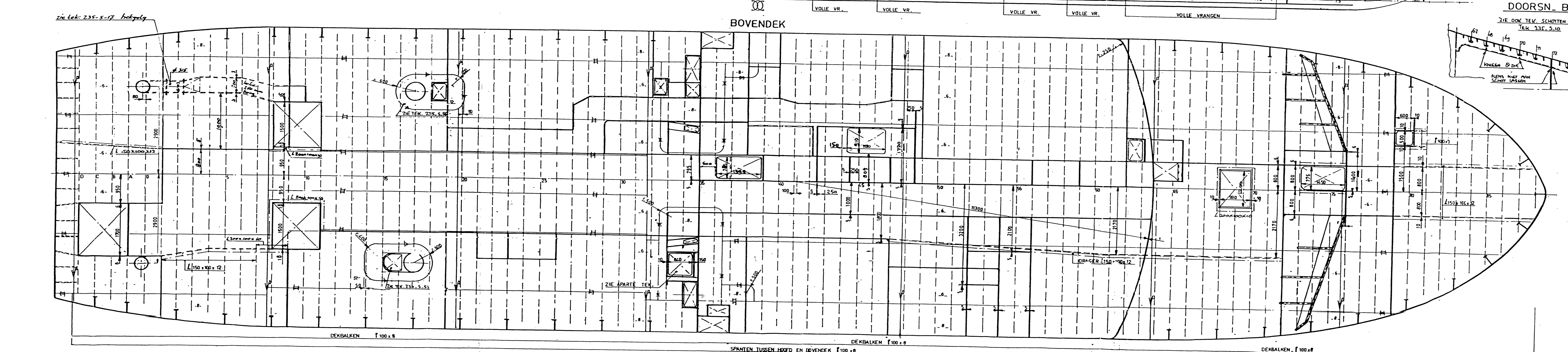
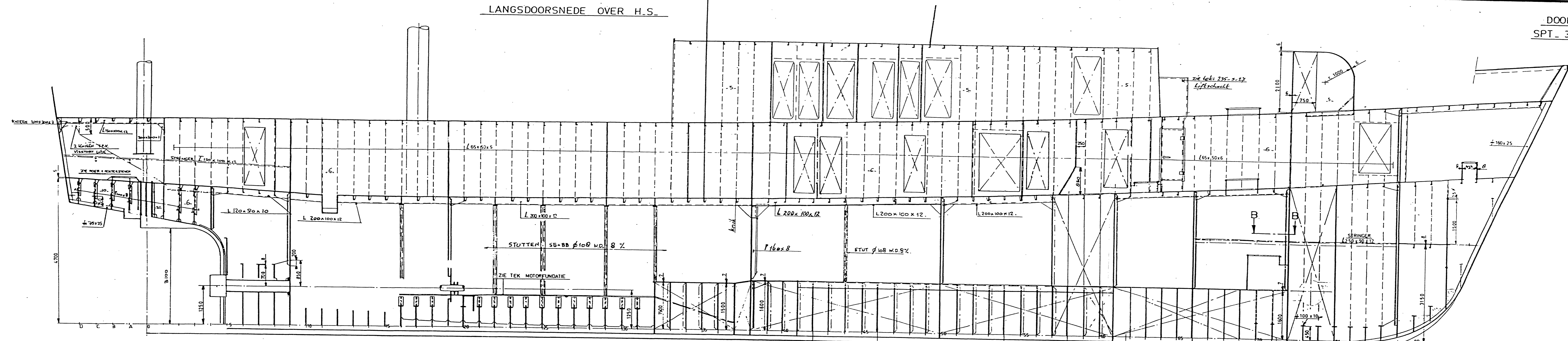
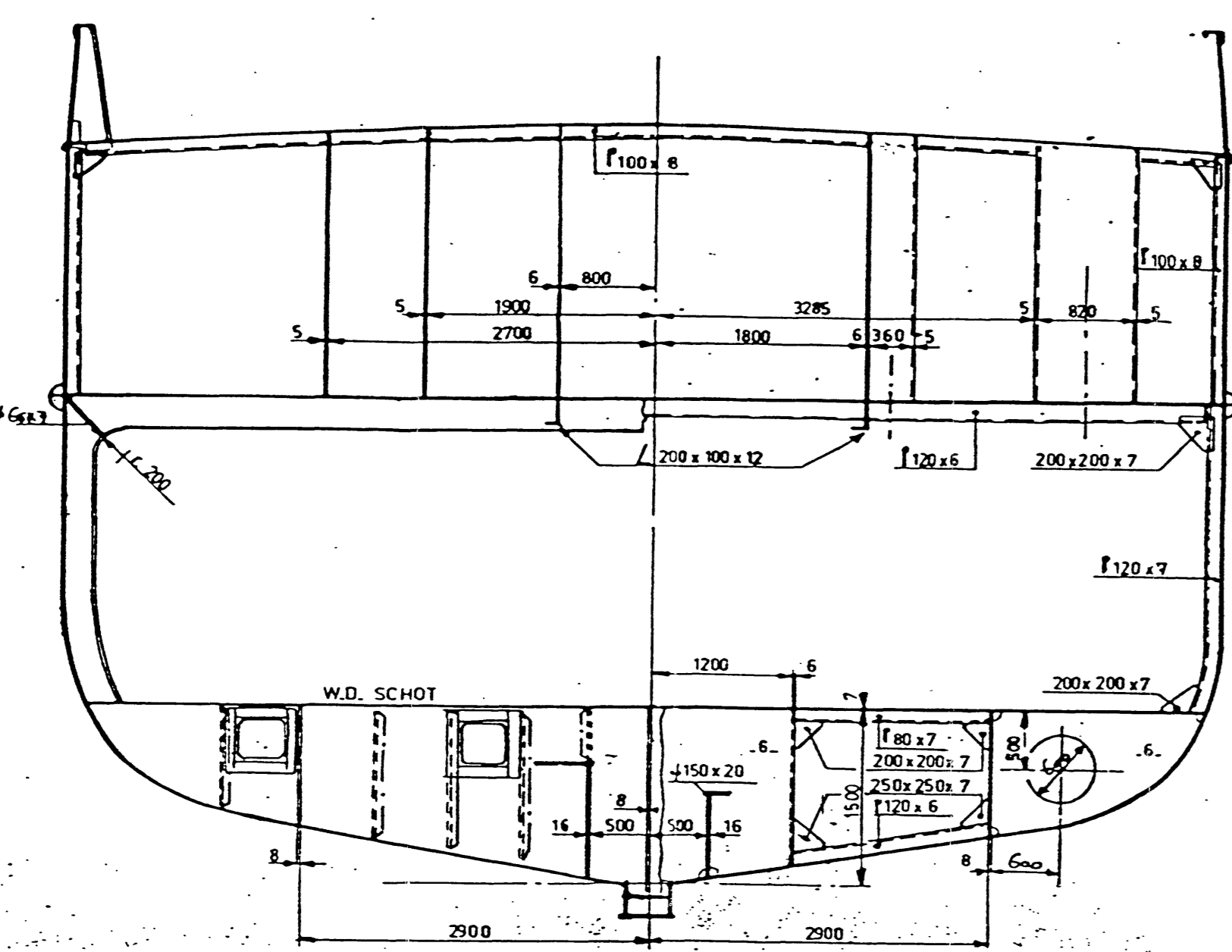
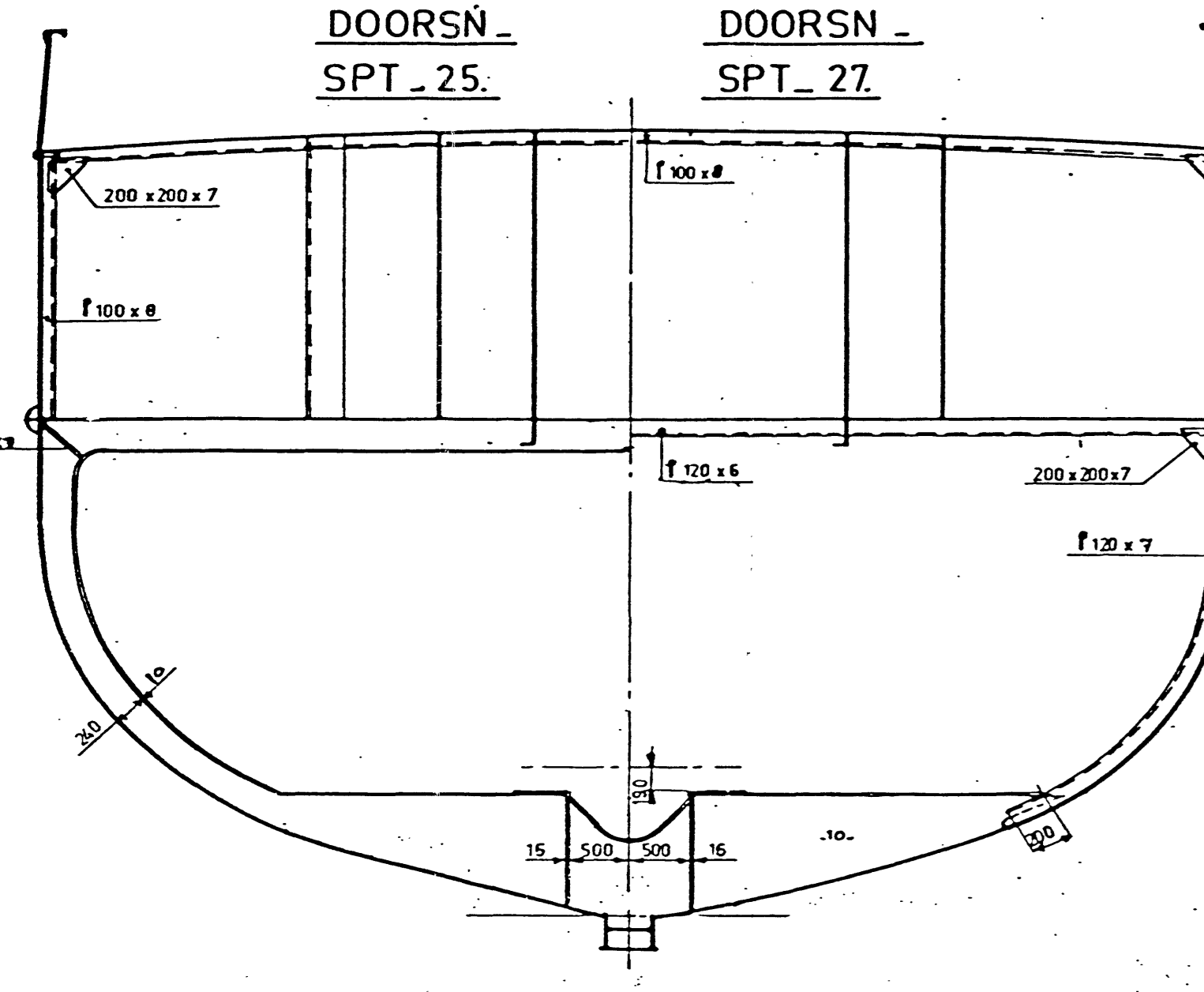
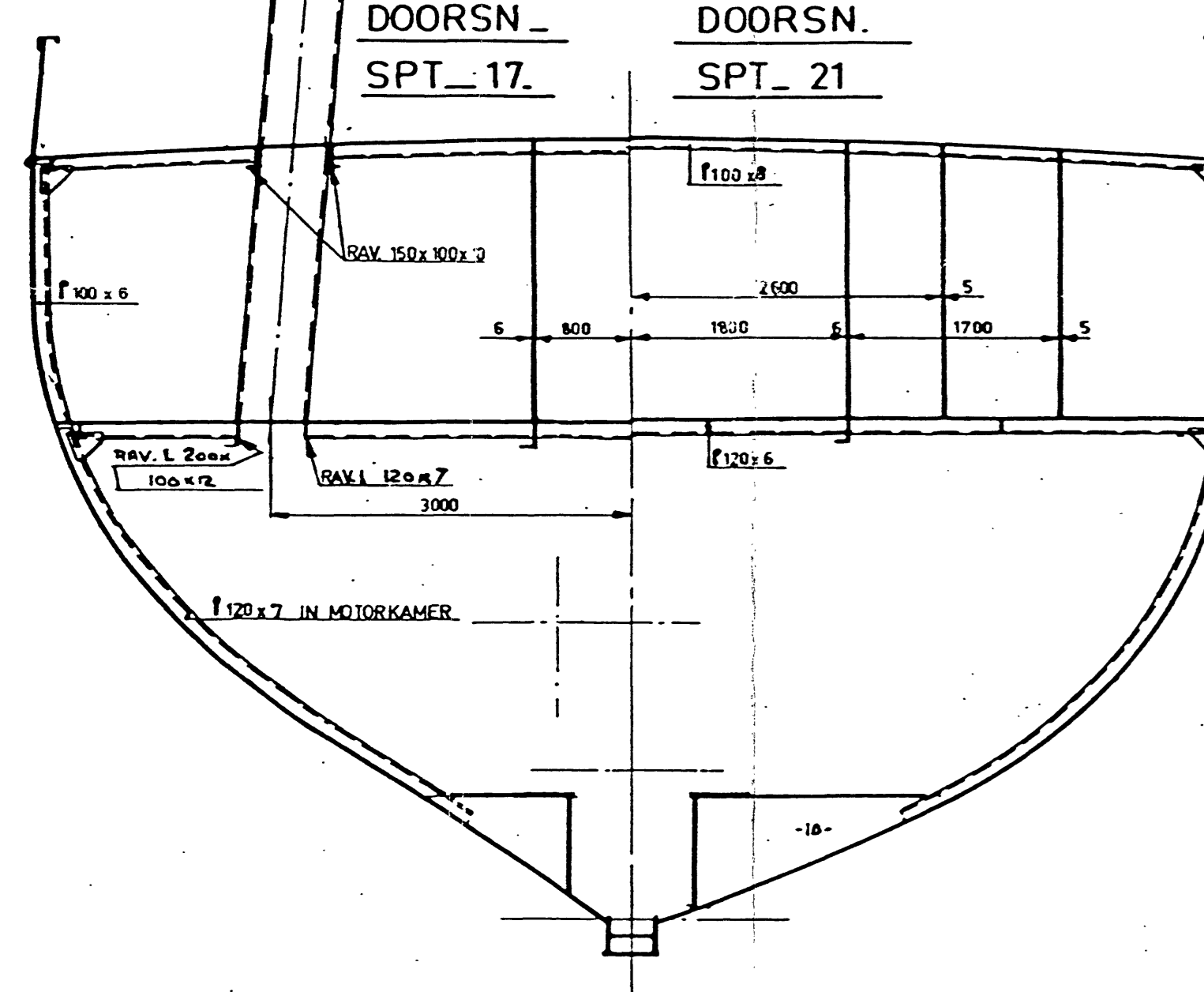
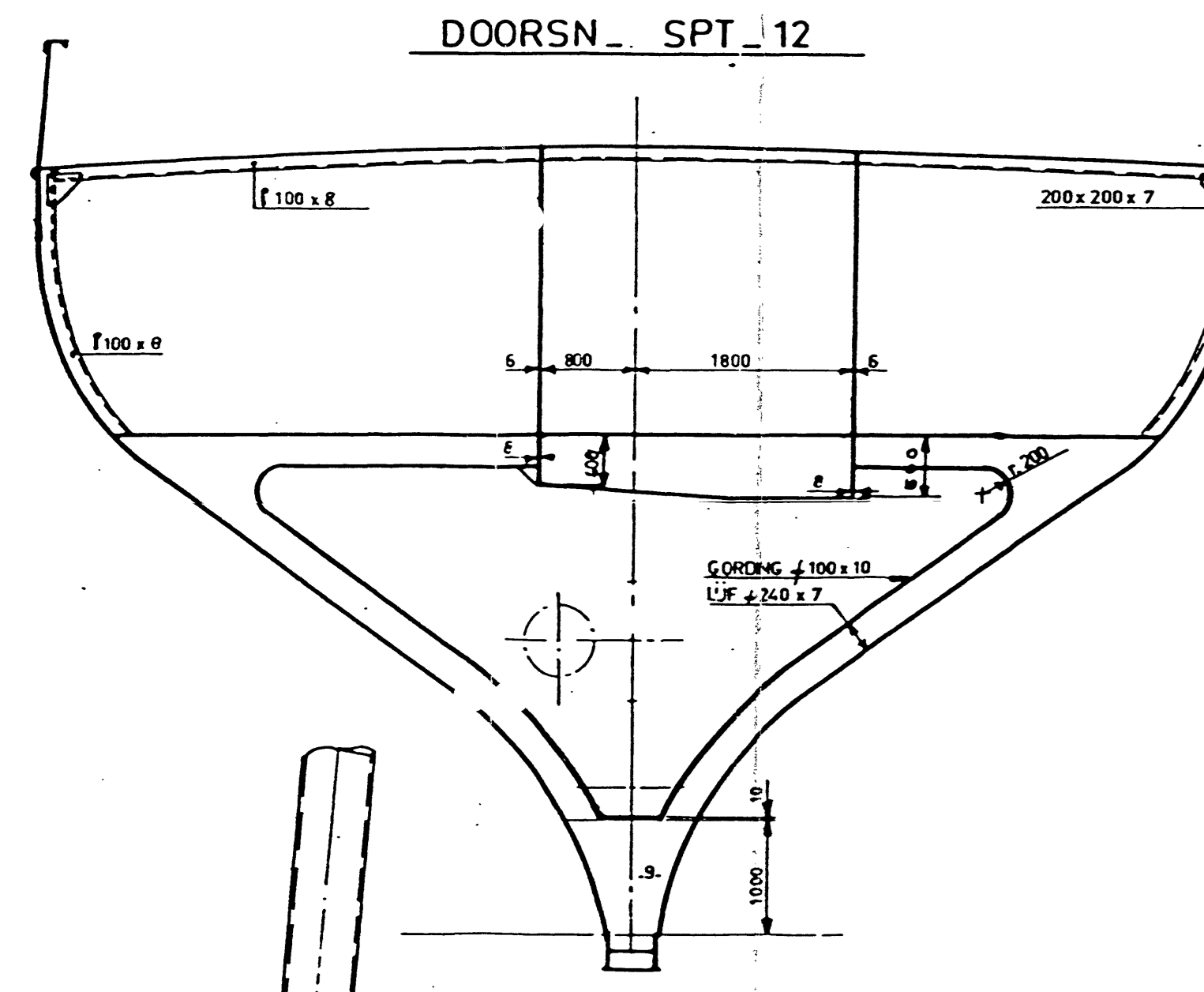
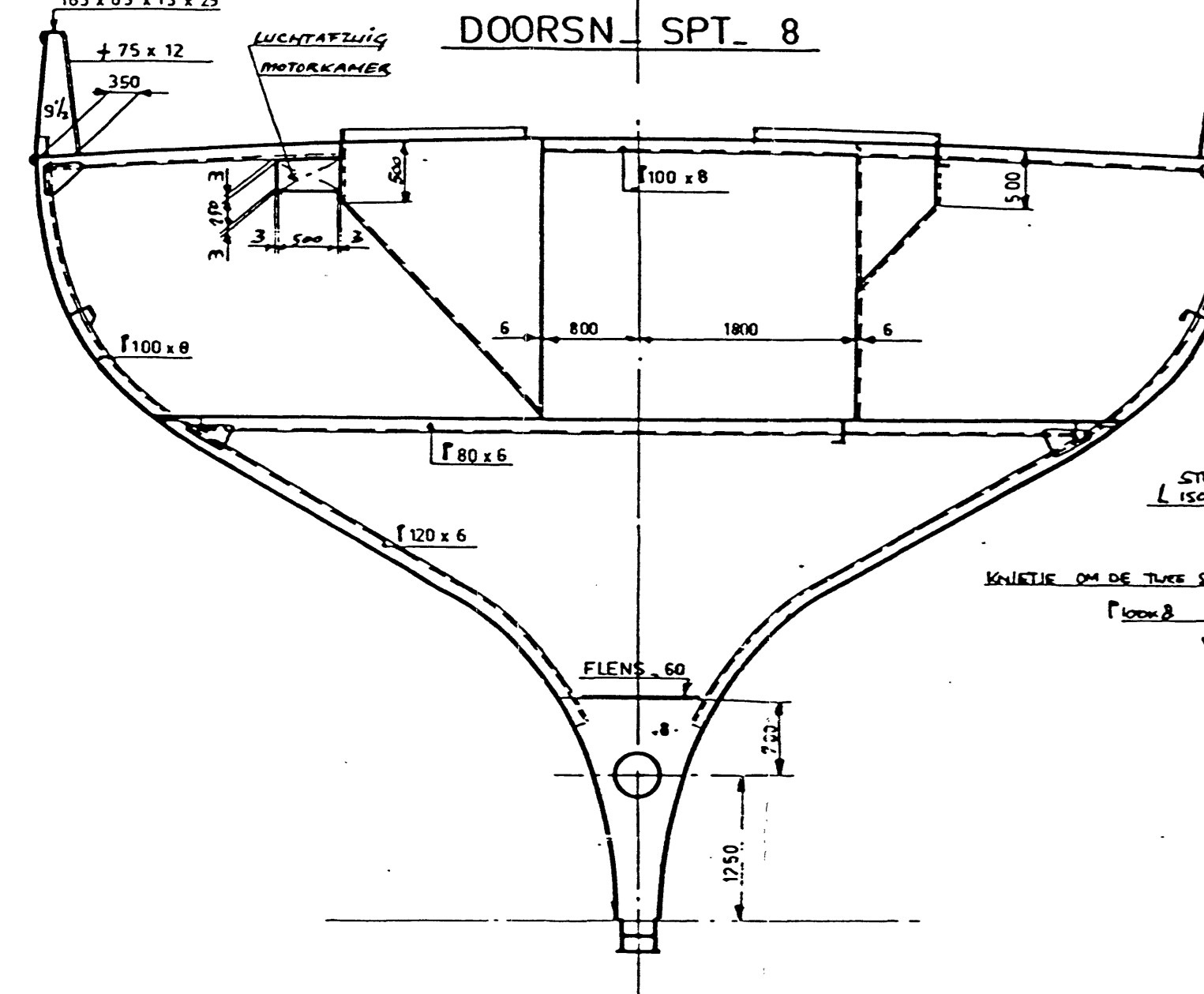
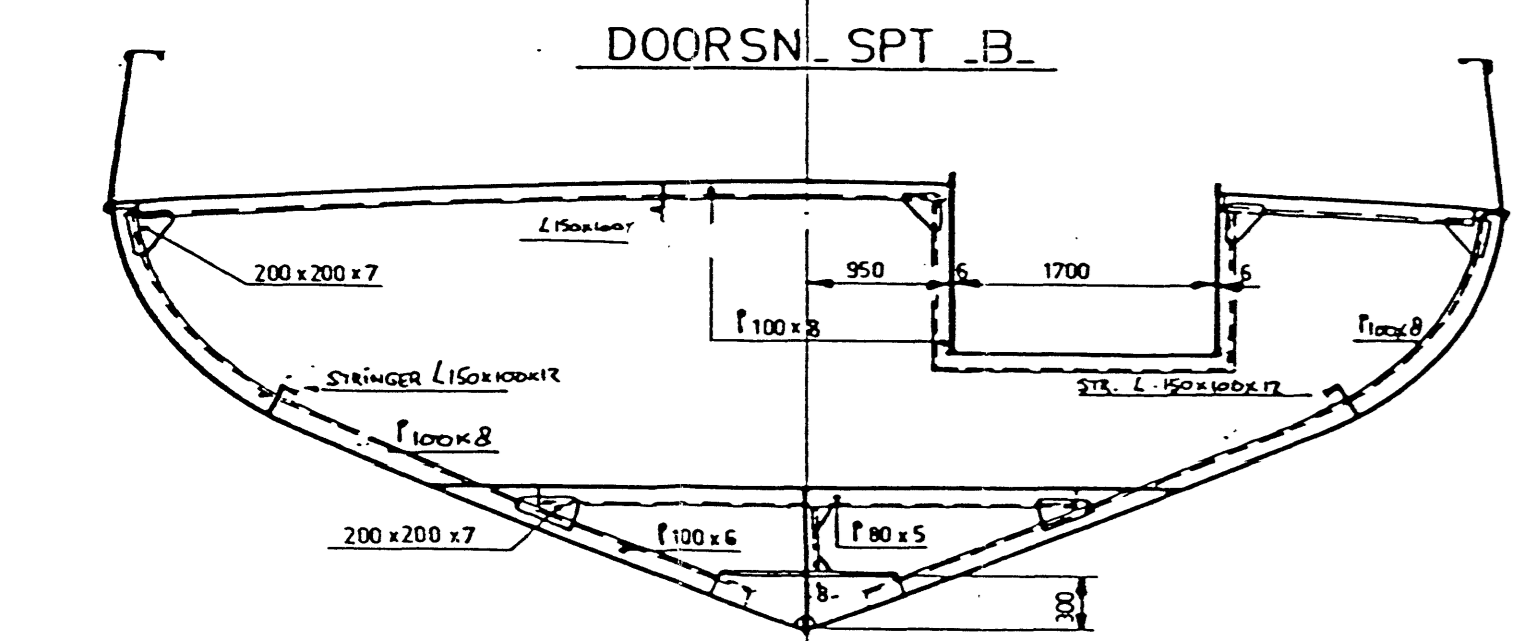

NOOT  
VOOR DUBB. BODEM:  
ZIE APARTE CONSTRUCTIE TEK.  
(ZIE TEK. 235.5.7.)

N.V. SLEEPHELLING MIJ „SCHEVENINGEN“  
CONSTRUCTIEPLAN  
24 MEI 1955

vuyk engineering	95 213-01	SCHAAL	1:50	DATUM	BOUWNUMMER
	013-001	GETEKEND	W. GROEN	22-03-55	235
CONSTRUCTIEPLAN		GEALQUEROED	GEZIEN	TEK. NR 235.5.6	